



“my
Reference,”

SAGA²

Gerflor[®]
theflooringgroup



Installation
with tackyfier
Adhésif repositionnable



Comfort & Resistance
*Envers liège :
confort et résistance*



<65dB
-15dB
Acoustic
Confort acoustique



90°installation
Pose à 90°

SAGA²

SAGA²

500 x 500 mm

0.70 mm 4.6 mm

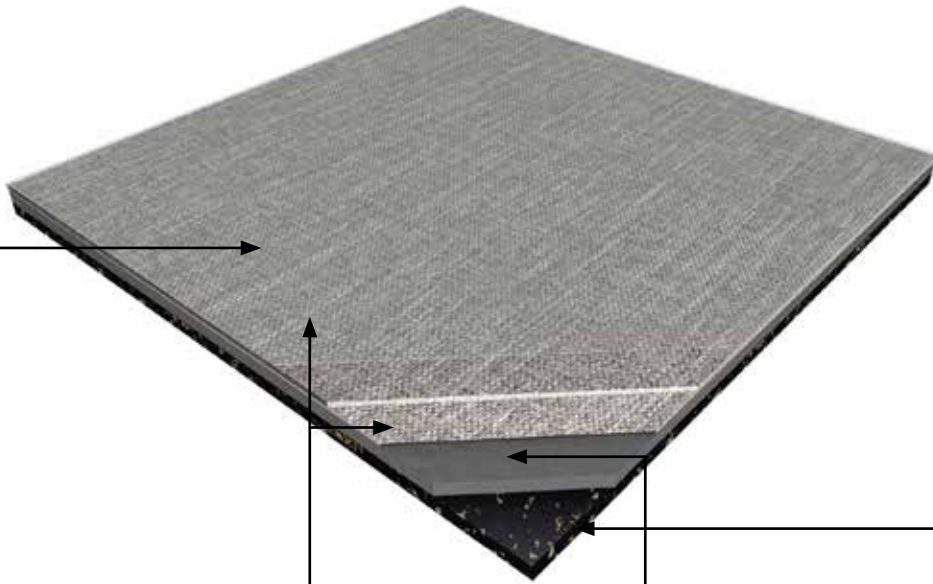

PROTECSOL®



Easy maintenance
Facilité d'entretien

4D DESIGN

STRUCTURED EMBOSSED
GRAINAGE STRUCTURÉ



Ultra realistic surface
Décor ultra réaliste

MATT SURFACE
SURFACE MATE



Natural look

CRYSTAL WEAR LAYER
COUCHE D'USURE CRISTAL



High definition design
& color
Décor haute définition

DESIGNS
DÉCORS

Exclusive designs
Décors exclusifs

RESILIENT CORE



Noise absorption
Sonorité à la marche
améliorée



Soft underfoot
Confort à la marche

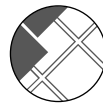

Renovation ceramic
5 mm joint
Pose sur carrelage
si joint < 5mm

CORK BACKING ENVERS LIÈGE



15 dB
Impact Sound Insulation
Isolation acoustique
bruits de choc



Environmental friendly
Un choix éco-responsable



Easily removable
Conception plombante
repositionnable

SAGA²

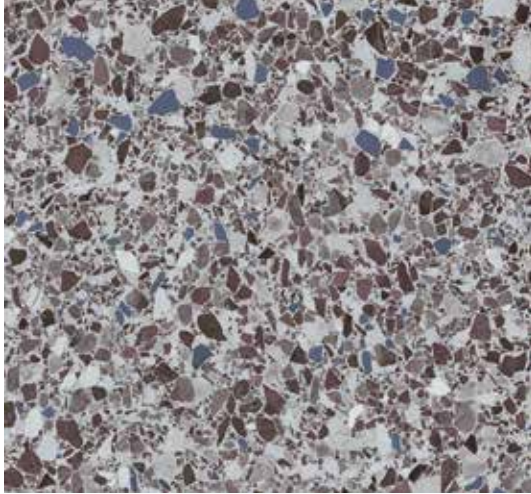

1089 Dalma Burgundy

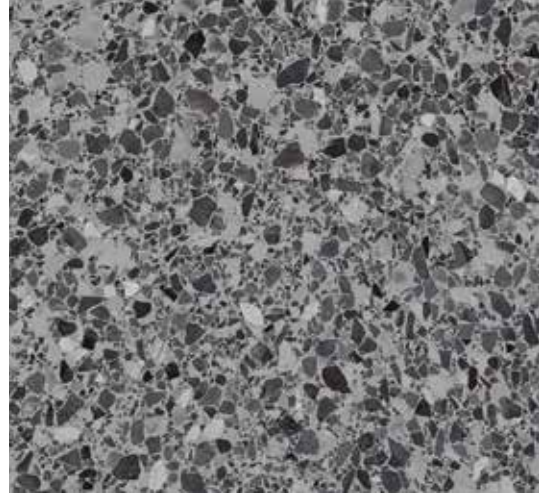

1088 Dalma Grey



0062 Rough Textile Beige



0063 Rough Textile Grey



0089 Gentleman Taupe



0088 Gentleman Grey





Rough Textile Grey



Dalma Burgundy

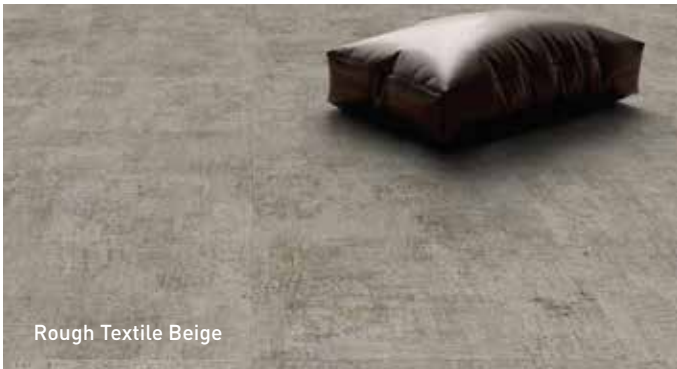

Rough Textile Beige



Dalma Grey



Gentleman Grey



Gentleman Taupe

SAGA²



0028 Fiber Silver

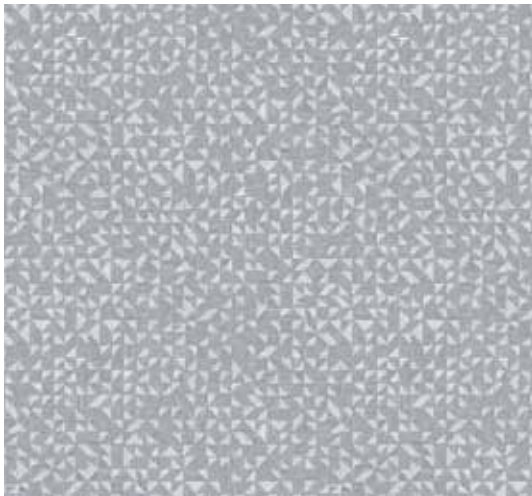

0032 Mozaic Grey

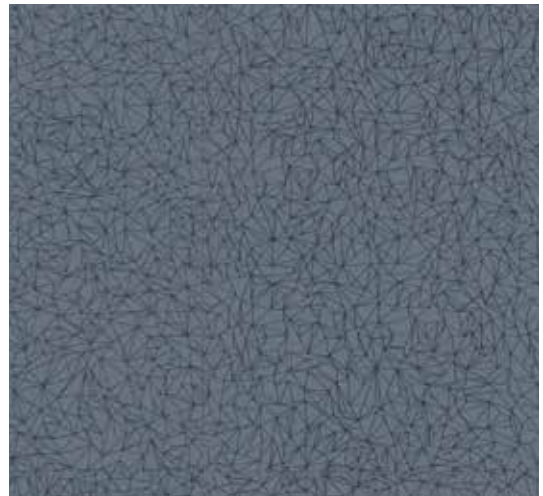

0039 Spider Blue



0021 Barma Sweet



0085 Dock Grey





Dock Grey

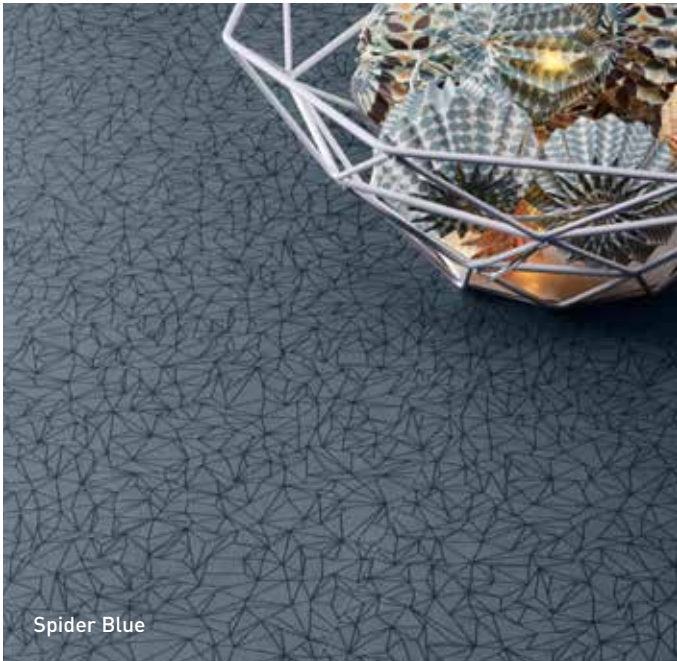

Spider Blue



Fiber Silver



Barma Sweet

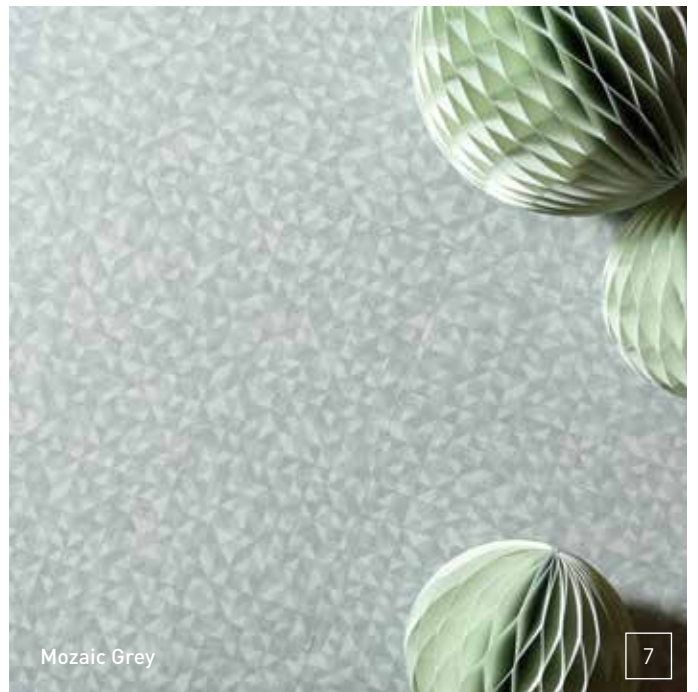

Mozaic Grey

SAGA²



0030 Gentleman Blue



0017 Kadina City



0027 Fiber Heavy Metal



0023 Barma Mystery



Gentleman Blue



Kadina City



Gentleman Blue



Barma Mystery



Fiber Heavy Metal

SAGA²

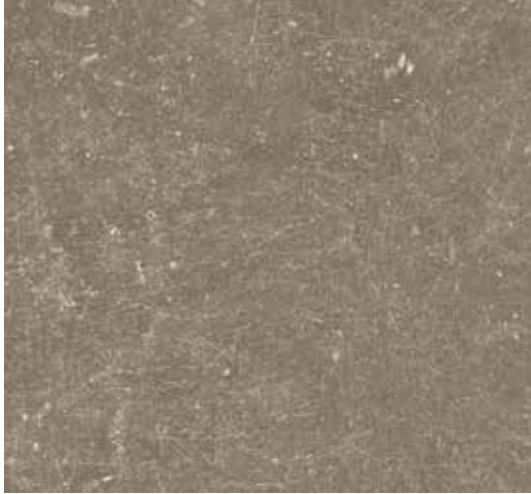

0087 Dock Taupe



0029 Gentleman Beige



0572 Amarante Dark



0579 Amarante



Dock Taupe



Gentleman Beige

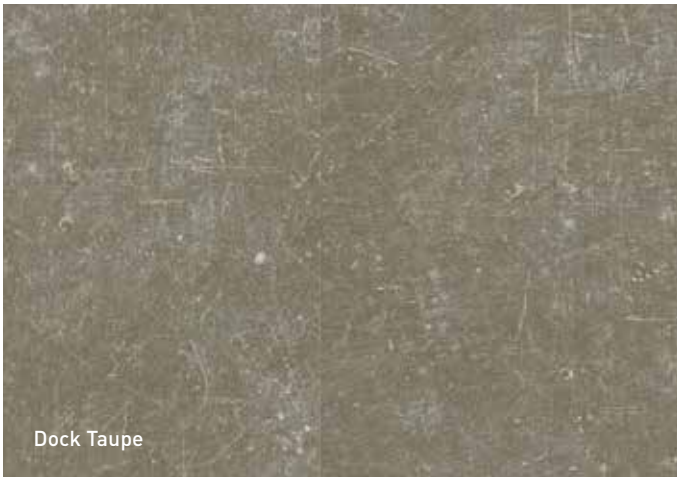

Dock Taupe



Amarante Dark



Amarante

SAGA²



0025 Barma Beige

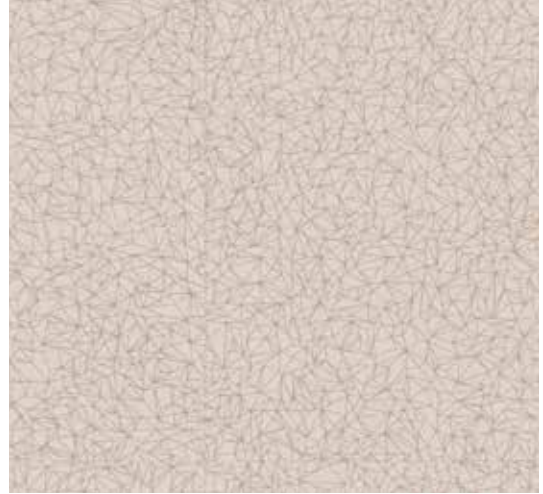

0033 Spider Beige



0577 Albion



0026 Fiber Copper





Fiber Copper



Barma Beige

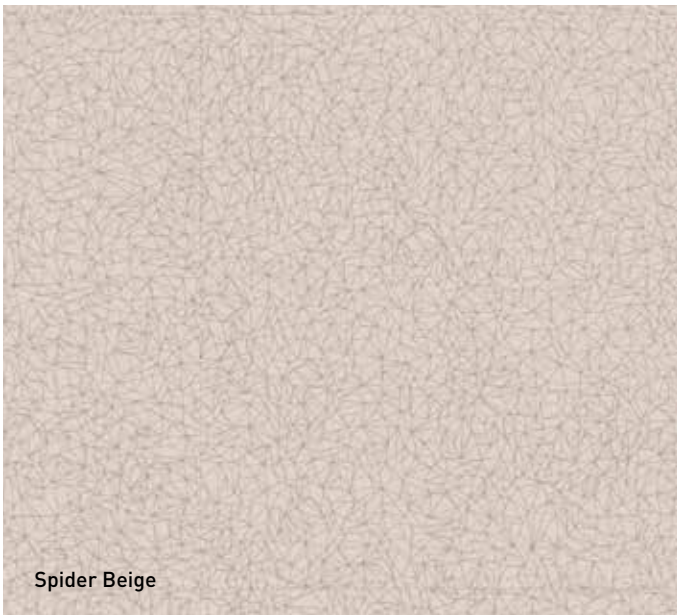

Spider Beige



Albion

PROFILES PROFILÉS

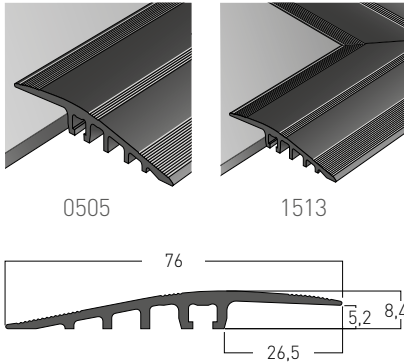

RAMP 5-6MM
(aluminium)
Ref. 0505



STAIRNOSING SOLUTION NEZ DE MARCHÉ

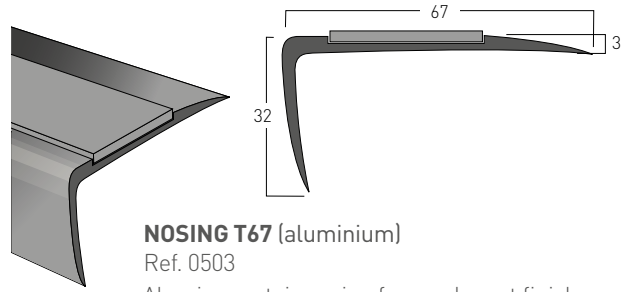

NOSING T67 (aluminium)
Ref. 0503

Aluminum stair nosing for an elegant finish to steps while increasing safety with its non-slip strip.

Nez de marche aluminium pour une harmonie palier/marche. Action anti-dérapante pour plus de sécurité.



ENTRANCE MATS TAPIS D'ENTRÉE



QUICK MAT*
Ref. 8550



LOOSELAY ROMAT GT INSERT KIT
Ref. 1719

SKIRTINGS PLINTHES

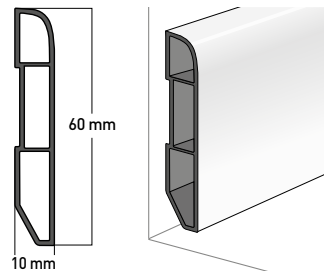

Ref. 6086 S001

VINYL WHITE SKIRTING

- Water resistant
- Can be adhesived
- Can be painted over

PLINTHE PVC BLANCHE

- Résistante à l'eau
- Peut être adhésivée
- Peut être peinte

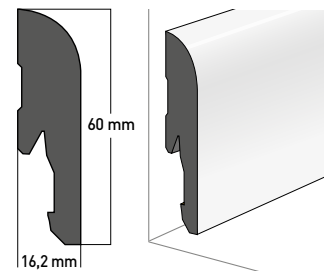

Ref. 5947 S001

MDF WHITE SKIRTING

- Can be clipped (ref. 5948)
- Nailed or adhesived
- Can be painted over

PLINTHE MDF BLANCHE

- Peut être clipsée (réf. 5948)
- Peut être clouée ou adhésivée
- Peut être peinte

DESCRIPTION / BESCHREIBUNG / BESCHRIJVING / DESCRIPTION / DESCRIPCIÓN / DESCRIÇÃO / DESCRIZIONE / BESKRIVNING / BESKRIVELSE

Total Thickness / Gesamtdicke / Totale dikte / Épaisseur totale / Espesor total / Espessura total / Spessore totale / Total tjøkkleik / Total tykkelse	EN ISO 24346	mm	4.60
	ASTM F386-02	inch	0.18
Thickness of the wearlayer / Dicke der Nuttschicht / Dikte van de slijtlaag / Épaisseur couche d'usure / Espesor capa de uso / Espessura camada de desgaste / Spessore strato di usura / Slitskikt tjøkkleik / Tykkelse slitesjikt	EN ISO 24340	mm	0.70
	ASTM F410-02	inch	0.03
Weight / Flächengewicht / Gewicht / Poids / Peso / Peso / Vikt / Vekt	EN ISO 23997	g/m ²	5595
Size / Format / Afmetingen / Format / Dimensiones / Dimensões / Dimensione / Storlek / Størrelse	ISO 24342	mm	500 x 500
	ASTM F 536	inch	19.685" x 19.685"
Number of tiles per package / Nombre de dalles par boîte / Cantidad de losetas / Caja	-	-	10

CLASSIFICATION / KLASSIFIKATION / CLASSIFICATIE / CLASSIFICATION / CLASIFICACIONES / CLASSIFICAÇÕES / CLASSIFICAZIONI / KLASSIFICERING / KLASSIFISERING

Norm/Product Specification / Produktnorm / Technische eigenschappen / Norme/Spécification produit / Normas / Normas / Norma prodotto / Norm/Produktspecificasjon / Norm	-	-	EN 652
	ASTM F 1700-04	-	Class III Type B
European Classification / Europäische Klassifizierung / Europee classificatie / Classement européen / Classificación europea / Classificação Europeia / Europea / Europaklass / Europaklasse	EN ISO 10874	Class	34-42
Classement UPEC	-	-	U4P3E2C2
Avis technique	-	n°	12/13-1655
Room Impact / Sonorité à la marche / Gehrschall	NFS 31 074	dB	< 65
Fire Rating / Brandverhalten / Brand classificatie / Classement Feu / Fuego / Fogo / Reazione al fuoco / Brandklassificering / Brannklassifisering	EN 13 501-1	Class	Bfl-s1
	ASTM E648-08	Class	1
	CAN/ULC S102.2	-	-
Static Electrical Propensity / Begehaufladung / Elektrische eigenschappen / Potentiel de charge / Comportamiento electrostático / Comportamento electrostático / Resistenza elettrica / Elektrisk oppladning / Elektrostatisk oppladning	EN 1815	kV	< 2
Slip Resistance Wet / Rutschhemmung / Anti-slip / Glissance humide / Deslizamiento húmedo / Escorregamento húmido / Scivolosità umida ⁽¹⁾ / Friktion / Friksjon, våt	DIN 51130/BGR 181	Class	R10 ⁽²⁾

PERFORMANCES / TECHNISCHE EIGENSCHAFEN / TESTRESULTAAT / PERFORMANCE / CARATTERISTICHE TECNICHE / TESTVÄRDEN / TESTVERDIER

Wear Resistance / Verschleißverhalten / Slijtvastheid / Résistance à l'usure / Abrasião / Abrasão / Resistenza all'abrasione / Slitagemotstånd / Slitestykke	EN 660.2	mm ³	≤ 2.0
Wear Group / Verschleißgruppe / Groep slijtvastheid / Groupe d'abrasion / Grupo de abrasión / Grupo de abrasão / Gruppo di abrasione / Slitklass / Slitasjegruppe	EN 652	group	T
Type Binder content / Teneur en agent liant	ISO 10582	group	-
Dimensional Stability / Maßstabilität / Maatvastheid / Stabilité dimensionnelle / Estabilidad dimensional / Estabilidade dimensional / Stabilità dimensionale / Dimensionsstabilität / Dimensjonsstabilitet	EN ISO 23999	%	≤ 0.15
Residual Indentation / Resteindruck / Indrukbelasting / Poinçonnement statique rémanent / Punzonamiento / Punçoamento / Impronta / Intrykksbestandighet / Inntrykksfasthet	EN ISO 24343-1	mm	< 0.13
Castor chair test / Stuhlrollenbeanspruchung / Rolweerstand bureaustoelen / Essai de la chaise à roulettes / Determinación del efecto de una silla con ruedas / Resistência a cadeiras de rodas / Resistenza al passaggio di sed / Tålighet mot rullande stolshjul / Rullende stolshjul (Type W)	ISO 4918	-	OK
Impact sound insulation / Trittschallverbesserungsmaß / Geluidsisolatie / Isolation acoustique bruits de chocs / Acústica / Isolamento acústico / Stegjudsdämpning / Trinnylidsdemping	EN ISO 717-2	dB	15
Impact insulation class (IIC)	ASTM E492	dB	IIC - 58dB
Thermal Conductivity / Wärmeleitfähigkeit / Thermische weerstand / Conductivité thermique / Conductividad térmica / Contutividade térmica / Resistenza termica / Värmeledningsmotstånd / Varmemotstand	EN ISO 10456	W/(m.K)	0.25
Colour Fastness / Lichtechtheit / Lichtechtheid / Solidité lumière / Resistencia a la luz / Estabilidade das cores / Solidità alla luce / Färgbeständighet / Fargebestandighet	EN 20 105 - B02	degree	≥ 6
Surface Treatment / Oberflächenvergütung / Oppervlaktebehandling / Traitement de surface / Tratamiento de superficie / Tratamento de superficie / Trattamento di superficie / Ytbehandling / Overflatebehandling	-	-	Protecsol®
Chemical Products Resistance / Verhalten gegenüber Chemikalien / Chemische bestendigheid / Résistance aux produits chimiques / Resistencia a los productos químicos / Resistência aos produtos químicos / Resistenza ai prodotti chimici / Kemikaliebestandighet / Kjemikaliebestandighet	EN ISO 26987	-	OK / Beständig gegenüber nicht färbenden alkoholhaltigen Handdesinfektionsmitteln, Haushaltschemikalien und verdünnten Säuren und Laugen bei kurzzeitiger Einwirkung

ENVIRONMENT/INDOOR AIR QUALITY / UMWELT/RAUMLUFTQUALITÄT / ENVIRONNEMENT/QUALITE DE L'AIR INTERIEUR / MEDIO AMBIENTE/CALIDAD INTERIOR DEL AIRE INTERIOR / MEIO AMBIENTE/QUALIDADE DO AR INTERIOR / INNOMHUSLUFT / EMISJONER

TVOC after 28 days / TVOC (28 Tage) / TVOC (28 dagen) / TVOC (28 dagen) / TVOC après 28 jours / TVOC (28 dias) / TVOC (28 dias) / TVOC (28 giorni) / TVOC (28 dagar) / TVOC (28 dager)	ISO 16000-6	µg/m ³	< 10
Certification / Zertifikat / Certification / Certificado / Certificação / Certifikat / Sertifisering	-	-	FloorScore®

CE MARKING / CE KENNZEICHNUNG / EG_CONFORMITEITSMERK / MARQUAGE CE / MARCA DE CONFORMIDAD CE / MARCA DE CONFORMIDADE CE / MARCATURA CE DI CONFORMITA / CE-MÅRKNING / CE MARKING

	EN 14041	-	   
--	----------	---	---

(1) Ramp test with oil / Schiefe Ebene / Plan incliné avec huile

(2) Glissance humide / Slip resistance wer / Rutschhemmung : details sur site gerflor.com / details on website gerflor.com / Einzelheiten auf der web-site gerflor.com

IMPORTANT: The information contained in this document is valid from 01/05/2017 and is subject to change at any time without notice. In the context of constantly changing technology, our customers are responsible, prior to any use, for checking with us that this document is the version in force.

IMPORTANT: Les informations contenues dans ce document sont valables à compter du : 01/05/2017 et susceptibles d'être modifiées à tout moment et sans préavis. L'évolution de la technique étant permanente, il appartient à notre clientèle avant toute mise en œuvre, de vérifier auprès de nos services que le présent document est bien celui en vigueur.



* Information sur le niveau d'émission de substances volatiles dans l'air intérieur, présentant un risque de toxicité par inhalation, sur une échelle de classe allant de A+ (très faibles émissions) à C (fortes émissions)

FRANCE : Gerflor Service Express

N°Azur 0 810 569 569
PRIX APPEL LOCAL

N°Azur FAX 0 810 569 570
PRIX APPEL LOCAL

e-mail : contactfrance@gerflor.com

OTHER COUNTRIES:

Gerflor International

Tel: +33 (0)4 74 05 40 00

Fax: +33 (0)4 74 05 03 13

e-mail: gerflorcontract@gerflor.com

Visualize your reference



interiordesigner.gerflor.com

30 years experience

Since 1985

Manufacturer

3 LVT Factories

World Class Logistics

12 Logistics Hubs

Gerflor Design Centre

Exclusive Designs



“Serenity,,

Julia - **End User**



“Time saving,,

Mika - **Installer**



“Design,,

Pierre - **Architect**



“Confidence,,

Claire - **Store Manager**



“Flexibility,,

Lucas - **Distributor**

That’s why Gerflor is our **Reference**

Gerflor[®]
the flooring group