



“my  
Reference,”

SAGA<sup>2</sup> Connect

**Gerflor**<sup>®</sup>  
theflooringgroup



**Interlocking installation  
with dovetails**  
*Assemblage grâce  
aux queues d'aronde*



**Adhesive free**  
*Pas d'adhésif*



**Fast and easy  
renovation**  
*Rénovation rapide et facile*



**All over effect**  
*Décor avec effet continu*

**SAGA<sup>2</sup> Connect**

# SAGA<sup>2</sup> Connect

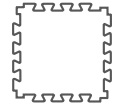

701.3 x 701.3 mm

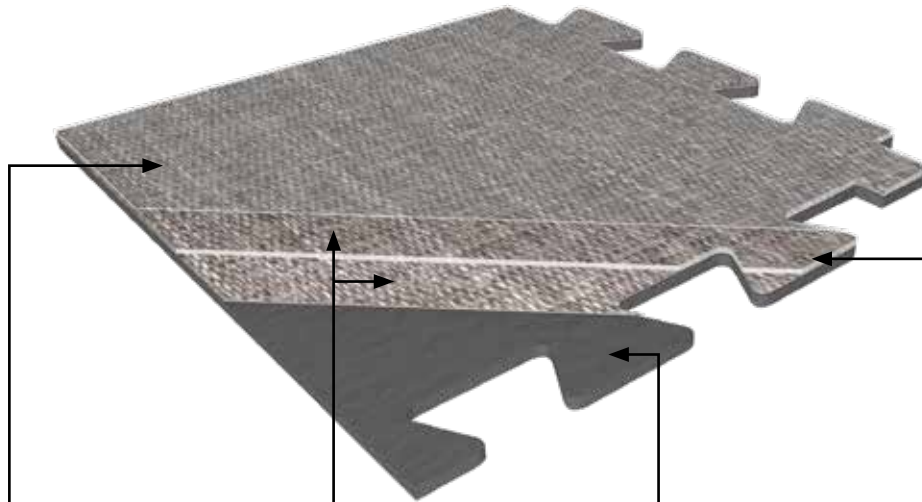
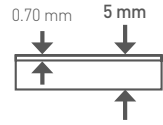

## PROTECSOL<sup>®</sup>



Easy maintenance  
Facilité d'entretien

## 4D DESIGN

STRUCTURED EMOSS  
GRAINAGE STRUCTURÉ

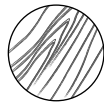

Ultra realistic surface  
Décor ultra réaliste

MATT SURFACE  
SURFACE MATE



Natural look

CRYSTAL WEAR LAYER  
COUCHE D'USURE CRISTAL



High definition design  
& color  
Décor haute définition

DESIGNS  
DÉCORS

Designs selected to hide  
dovetails - all over effect  
Décors masquant  
les queues d'aronde

## RESILIENT REINFORCED CORE

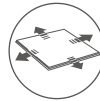

Glass particles  
for better stability  
Fibres de verre  
► stabilité dimensionnelle



Noise absorption  
Sonorité à la marche  
améliorée



Soft underfoot  
Confort à la marche



Renovation ceramic  
5 mm joint  
Pose sur carrelage  
si joint < 5mm

## EXCLUSIVE DOVETAILS QUEUES D'ARONDE



Gerflor patented  
Brevet Gerflor



No adhesive  
Pas d'adhésif



Easy installation  
Pose facile

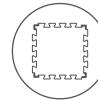

Avoid mistakes  
installation  
Limite les erreurs de pose



Resistant dovetails  
Queues d'aronde  
résistantes

# SAGA<sup>2</sup> Connect

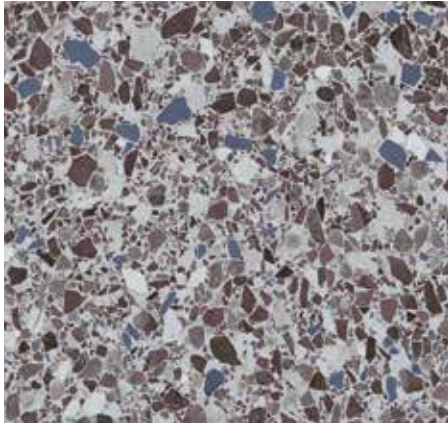

1089 Dalma Burgundy

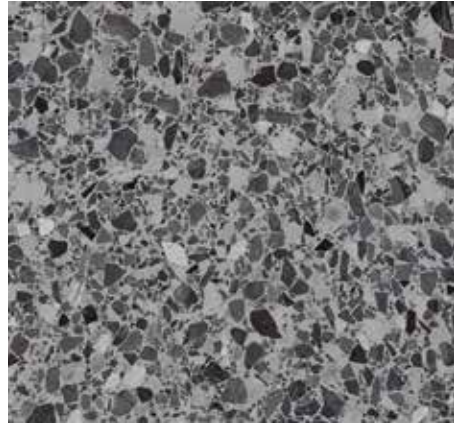

1088 Dalma Grey



0085 Dock Grey



0087 Dock Taupe



0062 Rough Textile Beige



0063 Rough Textile Grey



0089 Gentleman Taupe



0088 Gentleman Grey



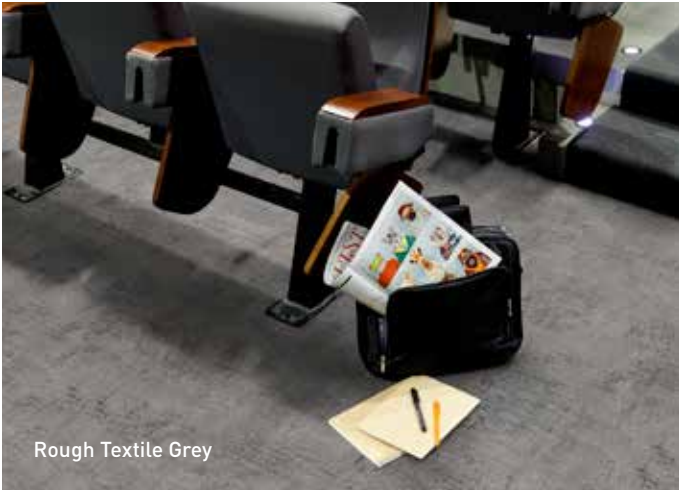

Rough Textile Grey



Dalma Burgundy



Rough Textile Beige



Dock Taupe



Gentleman Grey



Dalma Grey



Dock Grey



Gentleman Taupe

## PROFILES PROFILÉS

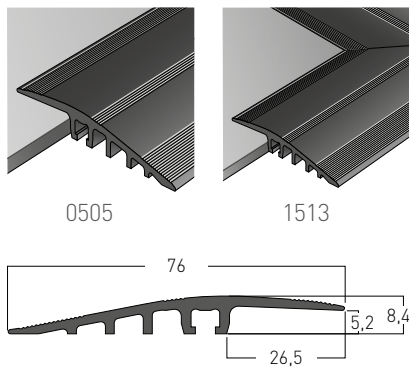

**RAMP 5-6MM**  
(aluminium)  
Ref. 0505



## STAIR NOSING SOLUTION NEZ DE MARCHE

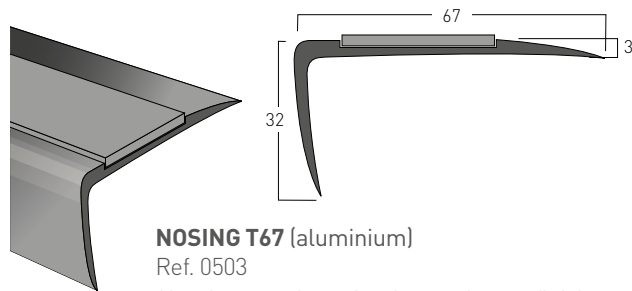

**NOSING T67** (aluminium)  
Ref. 0503

Aluminum stair nosing for an elegant finish to steps while increasing safety with its non-slip strip.

*Nez de marche aluminium pour une harmonie palier/marche. Action anti-dérapante pour plus de sécurité.*

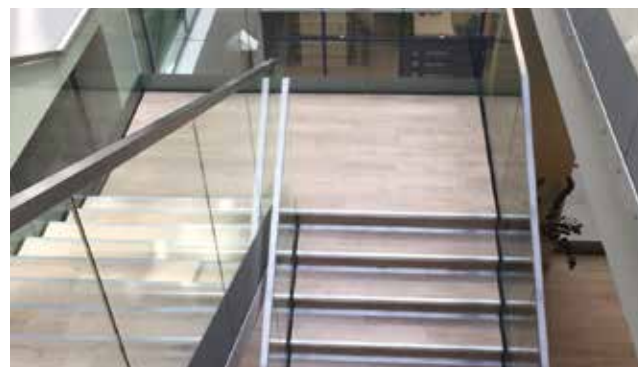

## ENTRANCE MATS TAPIS D'ENTRÉE



**QUICK MAT\***  
Ref. 8550



**LOOSELAY ROMAT GT INSERT KIT**  
Ref. 1719

## SKIRTINGS PLINTHES

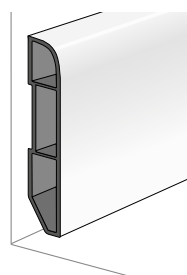
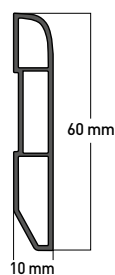

Ref. 6086 S001

### VINYL WHITE SKIRTING

- Water resistant
- Can be adhesived
- Can be painted over

### PLINTHE PVC BLANCHE

- Résistante à l'eau
- Peut être adhésivée
- Peut être peinte

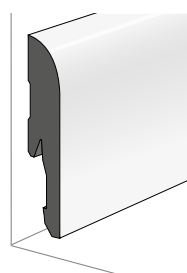
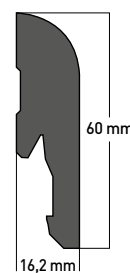

Ref. 5947 S001

### MDF WHITE SKIRTING

- Can be clipped (ref. 5948)
- Nailed or adhesived
- Can be painted over

### PLINTHE MDF BLANCHE

- Peut être clipsée (réf. 5948)
- Peut être clouée ou adhésivée
- Peut être peinte

# SAGA<sup>2</sup> Connect

SAGA<sup>2</sup> Connect

## DESCRIPTION / BESCHREIBUNG / BESCHRIJVING / DESCRIPTION / DESCRIPCIÓN / DESCRIÇÃO / DESCRIZIONE / BESKRIVNING / BESKRIVELSE

Total Thickness / Gesamtdicke / Totale dikte / Épaisseur totale / Espesor total / Espessura total / Spessore totale / Total tjocklek / Total tykkelse	EN ISO 24346	mm	5.00
	ASTM F386-02	inch	0.20
Thickness of the wearlayer / Dicke der Nuttschicht / Dikte van de slijtlaag / Épaisseur couche d'usure / Espesor capa de uso / Espessura camada de desgaste / Spessore strato di usura / Slitskikt tjocklek / Tykkelse slitesjikt	EN ISO 24340	mm	0.70
	ASTM F410-02	inch	0.03
Weight / Flächengewicht / Gewicht / Poids / Peso / Peso / Vikt / Vekt	EN ISO 23997	g/m <sup>2</sup>	8235
Size / Format / Afmetingen / Format / Dimensiones / Dimensões / Dimensio / Storlek / Størrelse	ISO 24342	mm	701.3 x 701.3
	ASTM F 536	inch	27.6" x 27.6"
Number of tiles per package / Nombre de dalles par boîte / Cantidad de losetas / Caja	-	-	100*

## CLASSIFICATION / KLASSIFIKATION / CLASSIFICATIE / CLASSIFICATION / CLASIFICACIONES / CLASSIFICAÇÕES / CLASSIFICAZIONI / KLASSIFICERING / KLASSIFISERING

Norm/Product Specification / Produktnorm / Technische eigenschappen / Norme/Spécification produit / Normas / Normas / Norma prodotto / Norm/Produktspezifikation / Norm	-	-	EN ISO 10582
	ASTM F 1700-04	-	Class III Type B
European Classification / Europäische Klassifizierung / Europese classificatie / Classement européen / Clasificación europea / Classificação Europeia / Europea / Europaklass / Europaklasse	EN ISO 10874	Class	34 - 43
<b>Classement UPEC</b>	-	-	<b>Pour pose dans des locaux classés U4P3E2C2</b>
<b>Avis technique</b>	-	n°	-
Room Impact / Sonorité à la marche / Gehschall	NFS 31 074	dB	75
Fire Rating / Brandverhalten / Brand classificatie / Classement Feu / Fuego / Fogo / Reazione al fuoco / Brandklassificering / Brannklassifisering	EN 13 501-1	Class	Br1-s1
	ASTM E648-08	Class	-
	CAN/ULC S102.2	-	-
Static Electrical Propensity / Begehaufldung / Elektrische eigenschappen / Potentiel de charge / Comportamiento electrostático / Comportamento electrostático / Resistenza elettrica / Elektrisk oppladning / Elektrostatisk oppladning	EN 1815	kV	< 2
Slip Resistance Wet / Rutschhemmung / Anti-slip / Glissance humide / Deslizamiento húmedo / Escorregamento húmido / Scivolosità umida / Friktion / Friksjon, våt	DIN 51130/BGR 181	Class	R10

## PERFORMANCES / TECHNISCHE EIGENSCHAFEN / TESTRESULTAAT / PERFORMANCE / CUALIDADES TÉCNICAS / PERFORMANCES / CARATTERISTICHE TECNICHE / TESTVÄRDEN / TESTVERDIER

Wear Resistance / Verschleißverhalten / Slijtvastheid / Résistance à l'usure / Abrasión / Abrasão / Resistenza all'abrasione / Slitagemotstånd / Slitestykke	EN 660.2	mm <sup>3</sup>	≤ 2.0
Wear Group / Verschleißgruppe / Groep slijtvasheid / Groupe d'abrasion / Grupo de abrasión / Grupo de abrasão / Gruppo di abrasione / Slitklass / Slitasjegruppe	EN 652	group	T
Type Binder content / Teneur en agent liant	ISO 10582	group	I
Dimensional Stability / Maßstabilität / Maatvastheid / Stabilité dimensionnelle / Estabilidad dimensional / Estabilidade dimensional / Stabilità dimensionale / Dimensionsstabilitet / Dimensjonsstabilitet	EN ISO 23999	%	≤ 0.15
Residual Indentation / Resteindruck / Indrukbelasting / Poinçonnement statique rémanent / Punzonamiento / Punctamento / Impronta / Intrycksbeständighet / Intrykksfasthet	EN ISO 24343-1	mm	≤ 0.10
Castor chair test / Stuhlrollenbeanspruchung / Rotweerstand bureaustoelen / Essai de la chaise à roulettes / Determinación del efecto de una silla con ruedas / Resistência a cadeiras de rodas / Resistenza al passaggio di sed / Tålighet mot rullande stolshjul / Rullende stolhjul (Type W)	ISO 4918	-	OK
Impact sound insulation / Trittschallverbesserungsmaß / Geluidsisolatie / Isolation acoustique bruits de chocs / Acústica / Isolamento acústico / Stegjudsdämpning / Trinnylidsdemping	EN ISO 717-2	dB	5
	ASTM E492	dB	-
Thermal Conductivity / Wärmeleitfähigkeit / Thermische weerstand / Conductivité thermique / Conductividad térmica / Contutividade térmica / Resistenza termica / Värmeledningsmotstånd / Varmemotstand	EN ISO 10456	W/(m.K)	0.25
Colour Fastness / Lichtechtheit / Lichtechtheid / Solidité lumière / Resistencia a la luz / Estabilidade das cores / Solidità alla luce / Färgbeständighet / Fargebestandighet	EN 20 105 - B02	degree	≥ 6
Surface Treatment / Oberflächenvergütung / Oppervlaktebehandling / Traitement de surface / Tratamiento de superficie / Tratamento de superficie / Trattamento di superficie / Ytbehandling / Overflatebehandling	-	-	Protecsol®
Chemical Products Resistance / Verhalten gegenüber Chemikalien / Chemische bestandigheid / Résistance aux produits chimiques / Resistencia a los productos químicos / Resistência aos produtos químicos / Resistenza ai prodotti chimici / Kemikaliebestandighet / Kjemikaliebestandighet	EN ISO 26987	-	OK

## ENVIRONMENT/INDOOR AIR QUALITY / UMWELT/RAUMLUFTQUALITÄT / ENVIRONNEMENT/QUALITE DE L'AIR INTERIEUR / MEDIO AMBIENTE/CALIDAD INTERIOR DEL AIRE INTERIOR / MEIO AMBIENTE/QUALIDADE DO AR INTERIOR / INNHOMSLUFT / EMISJONER

TVOC after 28 days / TVOC (28 Tage) / TVOC (28 dagen) / TVOC (28 dagen) / TVOC après 28 jours / TVOC (28 dias) / TVOC (28 dias) / TVOC (28 giorni) / TVOC (28 dagar) / TVOC (28 dager)	ISO 16000-6	µg/m <sup>3</sup>	< 10
Certification / Zertifikat / Certification / Certificado / Certificação / Certifikat / Sertifisering	-	-	-

## CE MARKING / CE KENNZEICHNUNG / EG\_CONFORMITEITSMERK / MARQUAGE CE / MARCA DE CONFORMIDAD CE / MARCA DE CONFORMIDADE CE / MARCATURA CE DI CONFORMITA / CE-MÄRKNING / CE MARKING

CE	EN 14041	-	   
----	----------	---	---

### \*Packaging:

Order by multiple of 20 tiles 49.14 sqm/box pallet (100 tiles)

Commande par multiple de 20 dalles, 100 dalles par Box Palett (49,14 m<sup>2</sup>)

**IMPORTANT:** The information contained in this document is valid from 01/09/2019 and is subject to change at any time without notice. In the context of constantly changing technology, our customers are responsible, prior to any use, for checking with us that this document is the version in force.

**IMPORTANT:** Les informations contenues dans ce document sont valables à compter du : 01/09/2019 et susceptibles d'être modifiées à tout moment et sans préavis. L'évolution de la technique étant permanente, il appartient à notre clientèle avant toute mise en œuvre, de vérifier auprès de nos services que le présent document est bien celui en vigueur.



\* Information sur le niveau d'émission de substances volatiles dans l'air intérieur, présentant un risque de toxicité par inhalation, sur une échelle de classe allant de A+ (très faibles émissions) à C (fortes émissions)

FRANCE : Gerflor Service Express

N°Azur 0 810 569 569  
PRIX APPEL LOCAL

N°Azur FAX 0 810 569 570  
PRIX APPEL LOCAL

e-mail : contactfrance@gerflor.com

**OTHER COUNTRIES:**

**Gerflor International**

Tel: +33 (0)4 74 05 40 00

Fax: +33 (0)4 74 05 03 13

e-mail: gerflorcontract@gerflor.com

**Visualize your reference**



[interiordesigner.gerflor.com](http://interiordesigner.gerflor.com)

**30 years experience**

Since 1985

**Manufacturer**

3 LVT Factories

**World Class Logistics**

12 Logistics Hubs

**Gerflor Design Centre**

Exclusive Designs



**“Serenity,,**

Julia - End User



**“Time saving,,**

Mika - Installer



**“Design,,**

Pierre - Architect



**“Confidence,,**

Claire - Store Manager



**“Flexibility,,**

Lucas - Distributor

That's why Gerflor is our **Reference**

**SAGA<sup>2</sup>: LESS SPEAKING FOR MORE ACTIONS**



**COMPOSITION**  
100% REACH  
Cork Backing



**INDOOR AIR QUALITY**  
10 times better than norms requirements  
(TVOC < 100 µg/m³ after 28 days)  
No formaldehyde emission



**RECYCLED CONTENT**  
55%



**RECYCLABILITY**  
100%



**LIFE CYCLE ANALYSIS**  
Eco-designed according to a product specific Life Cycle Analysis

**Gerflor**  
theflooringgroup